



SERVICE BULLETIN #135

05/31/2016

9562 Spoke Wheel

Upon depletion of inventory, the 9562 spoke will become obsolete with no direct replacement. We do however recommend a replacement: the 10-stud 2520 hub. This requires changing brake drums, changing to a disc hub, and changing to disc wheels instead of demountable rims. If you have any questions, please contact the Webb Engineering department via email to engineering@webbwheel.com or call 256-736-6356.

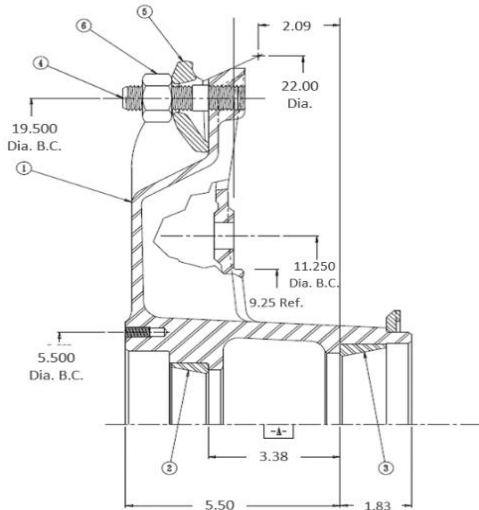

Obsolete Part

9562 Bill of Material			
Item	Part No.	Description	Qty
1	9562B	6 Spoke 22" ABS Wheel	1
2	3720	Outer Bearing Cup	1
3	HM212011	Inner Bearing Cup	1
4	171028	Rim Stud	6
5	16177	Rim Clamp	6
6	74710	Hex Nut	6

Replacement Option

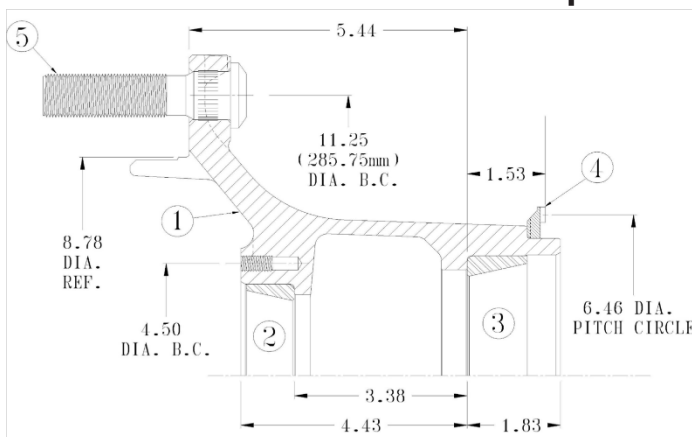

2520 Bill of Material			
Item	Part No.	Description	Qty
1	2520T	10 Stud 11.25" Outboard Steer Hub	1
2	3720	Outer Bearing Cup	1
3	HM212011	Inner Bearing Cup	1
4	51053	ABS Ring	1
5	Varies	Serrated Stud (M22x1.5 or 3/4-16)	10

REPLACEMENT ASSEMBLIES

Hub Service Assembly	Wheel Type	ABS
25201--PLT	BSN Steel or Aluminum	ABS
25201--PRT		ABS
25201--0T	No Studs	ABS
25201--1T	FN-Steel	ABS
25201--3T	FN-Aluminum	ABS

Replacement Drum Numbers	Size
65545B	15.00" x 4"
65153B	15.00" x 5"
65163B	16.50" x 5"
65179B	16.50" x 6"